



LEA is a collection of chairs and stools with an identity marked by a refined and light silhouette that is at the same time strong and unique. The curved shape of the backrest makes it comfortable and recognizable.

The family is made up of chairs and stools available in two heights. To achieve greater functionality, both the chairs and the stools are stackable. The design and the variety of finishes available, allow this to be a very transversal collection that can be easily integrated in diverse spaces and contexts such as: restaurants, cafes, workplaces, learning rooms and private residences.

FINISHES +info

Polypropylene seats & backs



Wooden seats & backs

Oak



Walnut



Steel frames

M1 colours



M2 colours

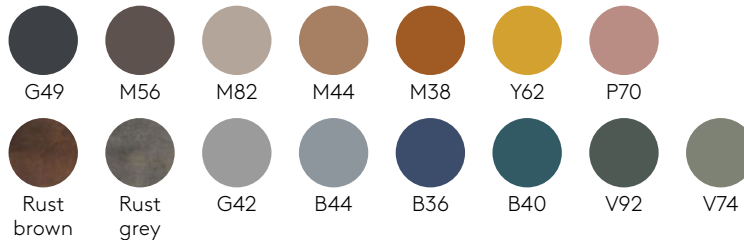

Upholstery: All fabrics and leathers indicated in our finishes book.

ENVIRONMENT & HEALTH

Environmental product data sheet [+info](#)

INCLASS production processes are certified according to environmental standards ISO 14001 in order to minimise any impact on the environment. ISO 14001 certificate [+info](#)



The products marked with this logo achieved GREENGUARD Gold Certification with all the fabrics from G1 to G7 [+info](#)

FIRE REQUIREMENTS

The slabstock polyurethane foam of the upholstered seats and backs meets:

BS 5852: Part 2, flame source 5 (CRIB 5) - Methods of test for assessment of the ignitability of upholstered seating by flaming ignition sources: Source 5 – Crib 5.

CAL TB 117 - Test method for the flame resistance of resilient cellular materials used in upholstered furniture: Ignition source – Open flame.

We recommend the use of wool or non-flammable synthetic fabrics.

Please contact our Customer Service department if your project has specific flammability needs or if you need to know if all components comply with the required standards.

QUALITY STANDARDS

The quality management system of INCLASS is certified in accordance with ISO 9001 in all the design, manufacturing and sales procedures of its products. ISO 9001 certificate [+info](#)

PRODUCT CERTIFICATIONS

UNE-EN 16139:2013vc2015

ANSI/BIFMA X5.4:2020

INCLASS products have been extensively tested to exceed industry testing standards at AIDIMME. AIDIMME is member of the European network INNOVAWOOD and its testing laboratories are accredited by ENAC.

COMPANY CERTIFICATIONS & ACCREDITATIONS

ISO 9001 - Quality management systems

ISO 14001 - Environmental management systems

FSC® - The mark of responsible forestry. Certificate C194846

AIDIMME Partner - Metal-processing, furniture, wood and packaging technology institute

IBV Partner - Valencia Institute of Biomechanics

ADVC Membership - Association of Designers of the Valencian Community

ENVALORA Membership - Collective System of Extended Producer Responsibility

WARRANTY

5 years

Chair with 4 leg frame (polypropylene seat & back)

Code: **LEA0010**



Stackable chair with seat and back in polypropylene. Four leg frame in round steel tube. Optionally the seat can be fully upholstered.

Remark: minimum order 2 units.

Seat and back finishes: surface with a matt non-slip micro texture. Available in colours PP1 from our polypropylene swatch card.

Frame finishes: micro-textured powder coated in colours M1 and M2 from our metallic swatch card.

Glides: plastic glides as standard. Felt glides and glides for carpet flooring are available with an upcharge.



Product with GREENGUARD Gold Certificate.

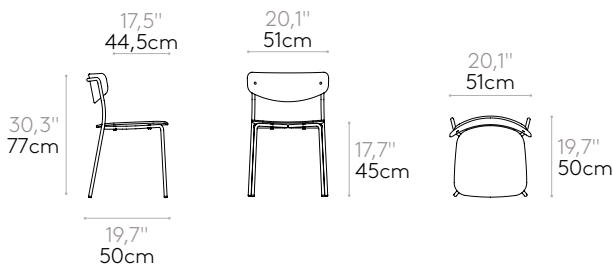

Recycled*

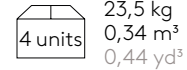

Armchair with 4 leg frame (polypropylene seat & back)

Code: **LEA0040**



Stackable armchair with seat and back in polypropylene. Four leg frame with arms in round steel tube. Optionally the seat can be fully upholstered.

Remark: minimum order 2 units.

Seat and back finishes: surface with a matt non-slip micro texture. Available in colours PP1 from our polypropylene swatch card.

Frame finishes: micro-textured powder coated in colours M1 and M2 from our metallic swatch card.

Glides: plastic glides as standard. Felt glides and glides for carpet flooring are available with an upcharge.



Product with GREENGUARD Gold Certificate.

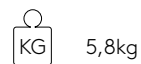
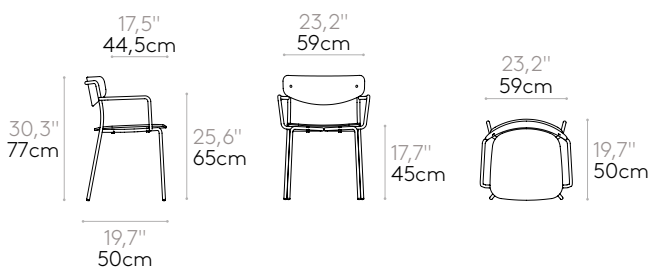

Recycled*

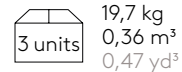

* Numbers may vary based on the exact options selected.

Armchair with 4 leg frame and armpads (polypropylene seat & back)

Code: **LEA0050**



Stackable armchair with polypropylene seat, back and armpads. Four leg frame with arms in round steel tube. Optionally the seat can be fully upholstered.

Remark: minimum order 2 units.

Seat, back and armpads finishes: surface with a matt non-slip micro texture. Available in colours PP1 from our polypropylene swatch card.

Frame finishes: micro-textured powder coated in colours M1 and M2 from our metallic swatch card.

Glides: plastic glides as standard. Felt glides and glides for carpet flooring are available with an upcharge.



Product with GREENGUARD Gold Certificate.

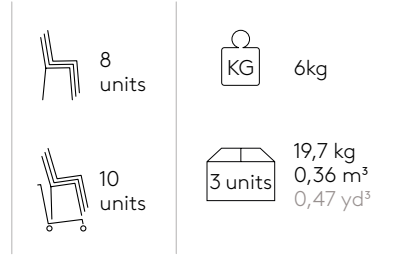
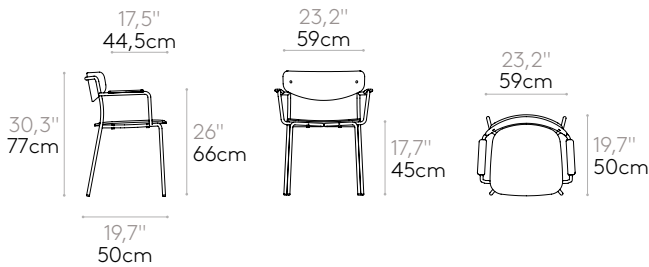

Medium stool with 4 leg frame (polypropylene seat & back)

Code: **LEA0020**



Stackable counter stool with seat and back in polypropylene. Four leg frame in round steel tube and footrest in steel rod. Optionally the seat can be fully upholstered.

Remark: this stool is only available in multiples of two units.

Seat and back finishes: surface with a matt non-slip micro texture. Available in colours PP1 from our polypropylene swatch card.

Frame finishes: micro-textured powder coated in colours M1 and M2 from our metallic swatch card.

Glides: plastic glides as standard. Felt glides and glides for carpet flooring are available with an upcharge.



Product with GREENGUARD Gold Certificate.

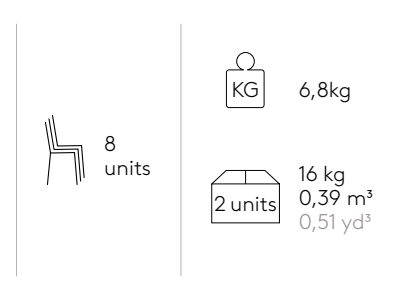
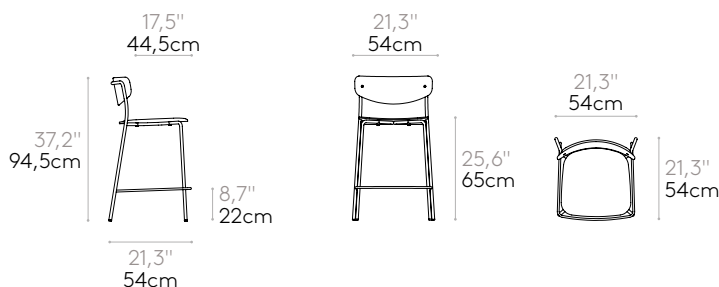

* Numbers may vary based on the exact options selected.

High stool with 4 leg frame (polypropylene seat & back)

Code: **LEA0030**



Stackable high stool with seat and back in polypropylene. Four leg frame in round steel tube and footrest in steel rod. Optionally the seat can be fully upholstered.

Remark: this stool is only available in multiples of two units.

Seat and back finishes: surface with a matt non-slip micro texture. Available in colours PP1 from our polypropylene swatch card.

Frame finishes: micro-textured powder coated in colours M1 and M2 from our metallic swatch card.

Glides: plastic glides as standard. Felt glides and glides for carpet flooring are available with an upcharge.



Product with GREENGUARD Gold Certificate.

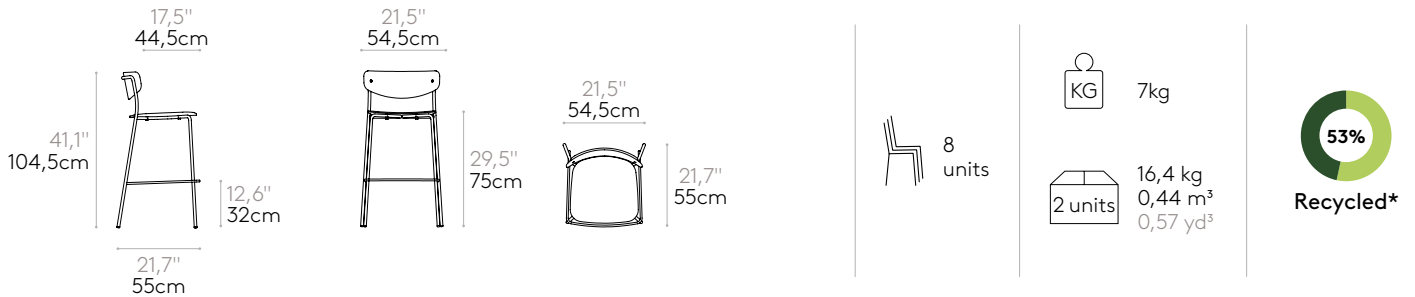

Upholstered seat for chair with plastic back (upcharge)

Code: **LEA0210AS**



COM 140cm / 55,1" per unit	
1 unit	65cm / 25,6"
8 or more units	55cm / 21,7"
COM will be priced as G2	

Optional fully upholstered seat. Inner seat made of polypropylene padded with CMHR slabstock polyurethane foam of 40kg/m³.

Upholstery: in all the fabrics and leathers indicated in our finishes book.



Product with GREENGUARD Gold Certificate.

* Numbers may vary based on the exact options selected.

Chair with 4 leg frame (wooden seat & back)

Code: **LEA0410**



Stackable chair with plywood seat and back. Four leg frame in round steel tube. Optionally the seat can be fully upholstered.

Remark: minimum order 2 units.

Seat and back finishes: in any of the oak and walnut finishes from our wood swatch card.

Frame finishes: micro-textured powder coated in colours M1 and M2 from our metallic swatch card.

Glides: plastic glides as standard. Felt glides and glides for carpet flooring are available with an upcharge.



Product with GREENGUARD Gold Certificate.

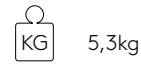
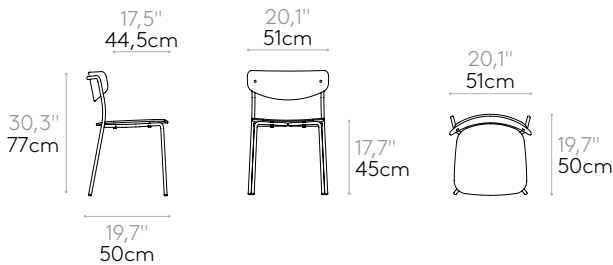

Recycled*

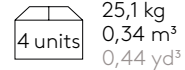

Armchair with 4 leg frame (wooden seat & back)

Code: **LEA0440**



Stackable armchair with plywood seat and back. Four leg frame with arms in round steel tube. Optionally the seat can be fully upholstered.

Remark: minimum order 2 units.

Seat and back finishes: in any of the oak and walnut finishes from our wood swatch card.

Frame finishes: micro-textured powder coated in colours M1 and M2 from our metallic swatch card.

Glides: plastic glides as standard. Felt glides and glides for carpet flooring are available with an upcharge.



Product with GREENGUARD Gold Certificate.

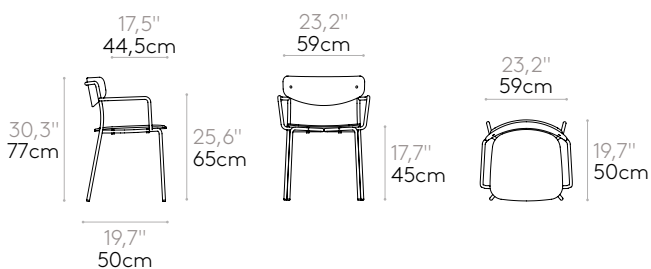

Recycled*

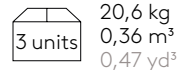

* Numbers may vary based on the exact options selected.

Armchair with 4 leg frame and arm pads (wooden seat & back)

Code: **LEA0450**



Stackable armchair with plywood seat and back and arm pads in solid oak. Four leg frame with arms in round steel tube. Optionally the seat can be fully upholstered.

Remark: minimum order 2 units.

Seat and back finishes: in any of the oak and walnut finishes from our wood swatch card.

Arm pads finishes: in any of the oak finishes from our wood swatch card.

Frame finishes: micro-textured powder coated in colours M1 and M2 from our metallic swatch card.

Glides: plastic glides as standard. Felt glides and glides for carpet flooring are available with an upcharge.



Product with GREENGUARD Gold Certificate.

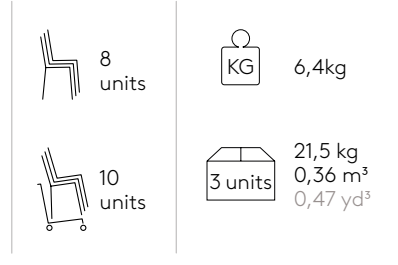
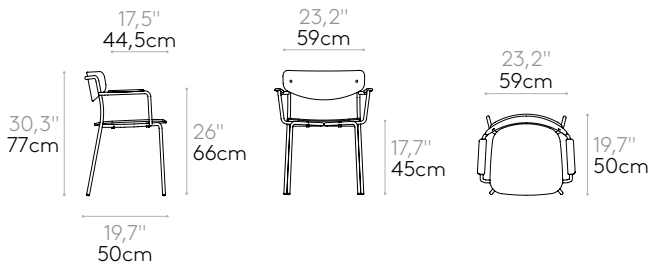

Medium stool with 4 leg frame (wooden seat & back)

Code: **LEA0420**



Stackable counter stool with plywood seat and back. Four leg frame in round steel tube and footrest in steel rod. Optionally the seat can be fully upholstered.

Remark: this stool is only available in multiples of two units.

Seat and back finishes: in any of the oak and walnut finishes from our wood swatch card.

Frame finishes: micro-textured powder coated in colours M1 and M2 from our metallic swatch card.

Glides: plastic glides as standard. Felt glides and glides for carpet flooring are available with an upcharge.



Product with GREENGUARD Gold Certificate.

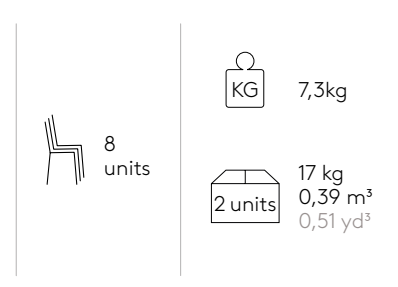
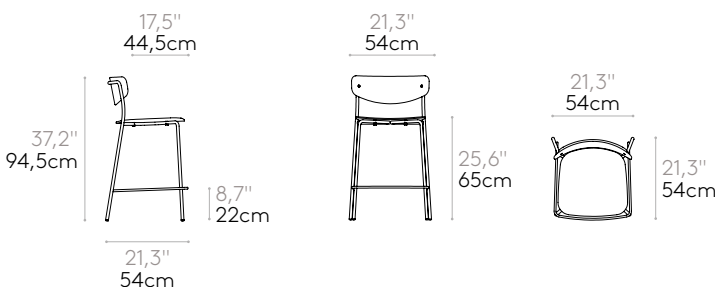

* Numbers may vary based on the exact options selected.

High stool with 4 leg frame (wooden seat & back)

Code: **LEA0430**



Stackable high stool with plywood seat and back. Four leg frame in round steel tube and footrest in steel rod. Optionally the seat can be fully upholstered.

Remark: this stool is only available in multiples of two units.

Seat and back finishes: in any of the oak and walnut finishes from our wood swatch card.

Frame finishes: micro-textured powder coated in colours M1 and M2 from our metallic swatch card.

Glides: plastic glides as standard. Felt glides and glides for carpet flooring are available with an upcharge.



Product with GREENGUARD Gold Certificate.

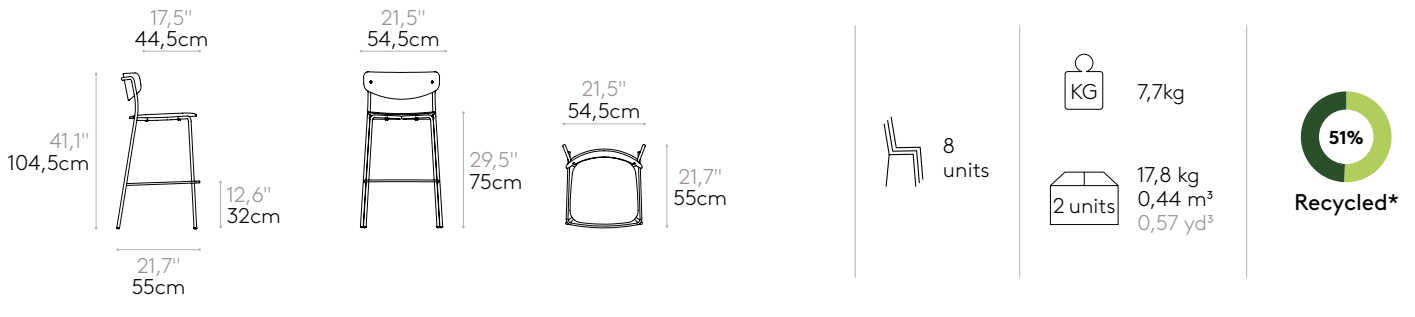

Upholstered seat for chair with wooden back (upcharge)

Code: **LEA0230AS**



COM 140cm / 55,1" per unit	
1 unit	65cm / 25,6"
8 or more units	55cm / 21,7"
COM will be priced as G2	

Optional fully upholstered seat. Inner seat made of polypropylene padded with CMHR slabstock polyurethane foam of 40kg/m³.

Upholstery: in all the fabrics and leathers indicated in our finishes book.



Product with GREENGUARD Gold Certificate.

* Numbers may vary based on the exact options selected.

Chair with 4 leg frame (upholstered seat & back)

Code: **LEA0610**



Stackable chair with fully upholstered seat and back. Four leg frame in round steel tube. Inner seat and backrest made of polypropylene padded with CMHR slabstock polyurethane foam of 40kg/m³.

Remark: minimum order two units.

Upholstery: in all the fabrics and leathers indicated in our finishes book.

Frame finishes: micro-textured powder coated in colours M1 and M2 from our metallic swatch card.

Glides: plastic glides as standard. Felt glides and glides for carpet flooring are available with an upcharge.



Product with GREENGUARD Gold Certificate.

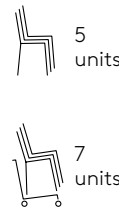
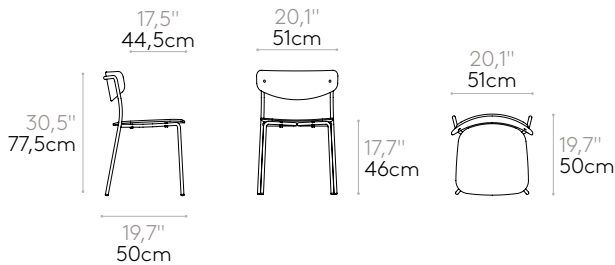

COM 140cm / 55,1" per unit

1 unit	90cm / 35,4"
--------	--------------

8 or more units	80cm / 31,5"
-----------------	--------------

COM will be priced as G2

KG 5,7kg

3 units 21 kg
0,38 m³
0,50 yd³



Recycled*

Armchair with 4 leg frame (upholstered seat & back)

Code: **LEA0640**



Stackable armchair with fully upholstered seat and back. Four leg frame with arms in round steel tube. Inner seat and backrest made of polypropylene padded with CMHR slabstock polyurethane foam of 40kg/m³.

Remark: minimum order 2 units.

Upholstery: in all the fabrics and leathers indicated in our finishes book.

Frame finishes: micro-textured powder coated in colours M1 and M2 from our metallic swatch card.

Glides: plastic glides as standard. Felt glides and glides for carpet flooring are available with an upcharge.



Product with GREENGUARD Gold Certificate.

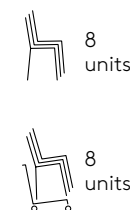
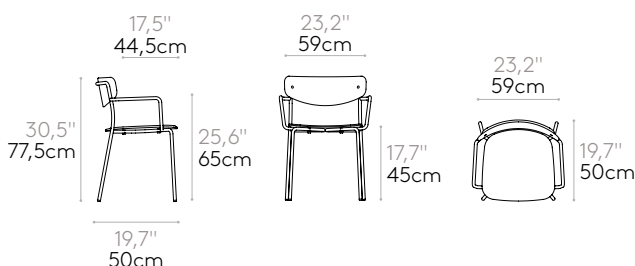

COM 140cm / 55,1" per unit

1 unit	90cm / 35,4"
--------	--------------

8 or more units	80cm / 31,5"
-----------------	--------------

COM will be priced as G2

KG 6,5kg

3 units 21,8 kg
0,36 m³
0,47 yd³

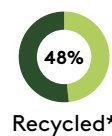

Recycled*

* Numbers may vary based on the exact options selected.

Armchair with 4 leg frame and armpads (upholstered seat & back)

Code: **LEA0650**



Stackable armchair with fully upholstered seat and back and polypropylene armpads. Four leg frame with arms in round steel tube. Inner seat and backrest made of polypropylene padded with CMHR slabstock polyurethane foam of 40kg/m³.

Remark: minimum order 2 units.

Upholstery: in all the fabrics and leathers indicated in our finishes book.

Armpads finishes: surface with a matt non-slip micro texture. Available in colours PP1 from our polypropylene swatch card.

Frame finishes: micro-textured powder coated in colours M1 and M2 from our metallic swatch card.

Glides: plastic glides as standard. Felt glides and glides for carpet flooring are available with an upcharge.



Product with GREENGUARD Gold Certificate.

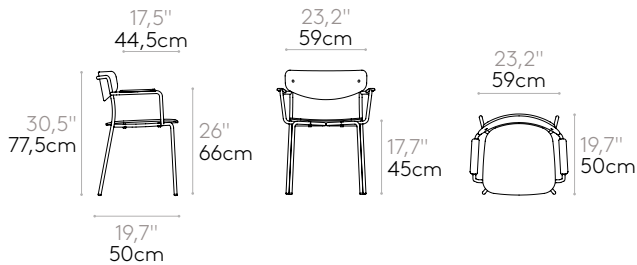

8 units



8 units

COM 140cm / 55,1" per unit

1 unit	90cm / 35,4"
8 or more units	80cm / 31,5"

COM will be priced as G2

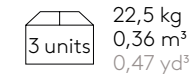
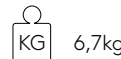

Recycled*

Medium stool with 4 leg frame (upholstered seat & back)

Code: **LEA0620**



Stackable counter stool with fully upholstered seat and back. Four leg frame in round steel tube and footrest in steel rod. Inner seat and backrest made of polypropylene padded with CMHR slabstock polyurethane foam of 40kg/m³.

Remark: this stool is only available in multiples of two units.

Upholstery: in all the fabrics and leathers indicated in our finishes book.

Frame finishes: micro-textured powder coated in colours M1 and M2 from our metallic swatch card.

Glides: plastic glides as standard. Felt glides and glides for carpet flooring are available with an upcharge.



Product with GREENGUARD Gold Certificate.

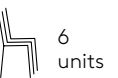
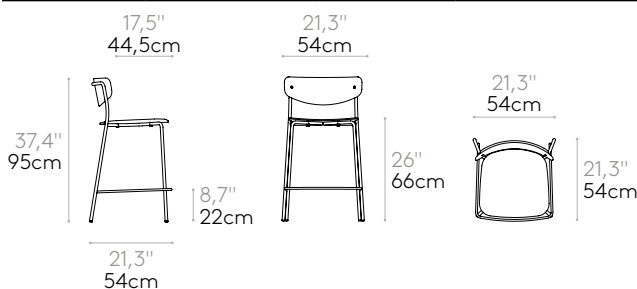

6 units

COM 140cm / 55,1" per unit

1 unit	90cm / 35,4"
8 or more units	80cm / 31,5"

COM will be priced as G2

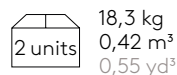
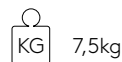

Recycled*

* Numbers may vary based on the exact options selected.

High stool with 4 leg frame (upholstered seat & back)

Code: **LEA0630**



Stackable high stool with fully upholstered seat and back. Four leg frame in round steel tube and footrest in steel rod. Inner seat and backrest made of polypropylene padded with CMHR slabstock polyurethane foam of 40kg/m³.

Remark: this stool is only available in multiples of two units.

Upholstery: in all the fabrics and leathers indicated in our finishes book.

Frame finishes: micro-textured powder coated in colours M1 and M2 from our metallic swatch card.

Glides: plastic glides as standard. Felt glides and glides for carpet flooring are available with an upcharge.



Product with GREENGUARD Gold Certificate.

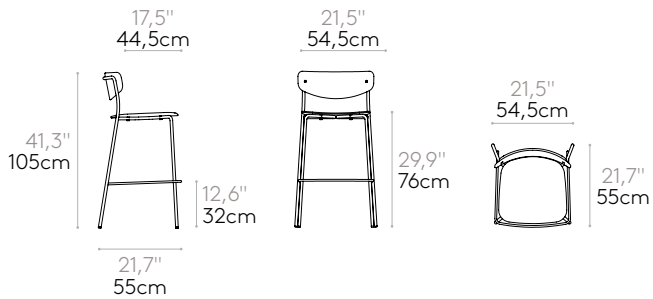

COM 140cm / 55,1" per unit

1 unit	90cm / 35,4"
8 or more units	80cm / 31,5"

COM will be priced as G2

KG 6kg

2 units 19,3 kg
0,44 m³
0,57 yd³



Recycled*

* Numbers may vary based on the exact options selected.

OPTIONAL ITEMS & ACCESSORIES

Code	Description
	LEA0140OP Set of 4 felt glides for 4 leg frame (upcharge)

LEA0142OP	Set of 4 glides for carpet flooring for 4 leg frame (upcharge)
-----------	--

Upholstered seat cushion

Code: **LEA0220AS**



COM 140cm / 55,1" per unit	
1 unit	54cm / 21,3"
8 or more units	48,5cm / 19,1"
COM will be priced as G2	

Optional removable upholstered seat cushion fixed with velcro. Inner seat made of CMHR slabstock polyurethane foam of 40kg/m³.

Upholstery: in all the fabrics and leathers indicated in our finishes book.



Product with GREENGUARD Gold Certificate.

* Numbers may vary based on the exact options selected.